

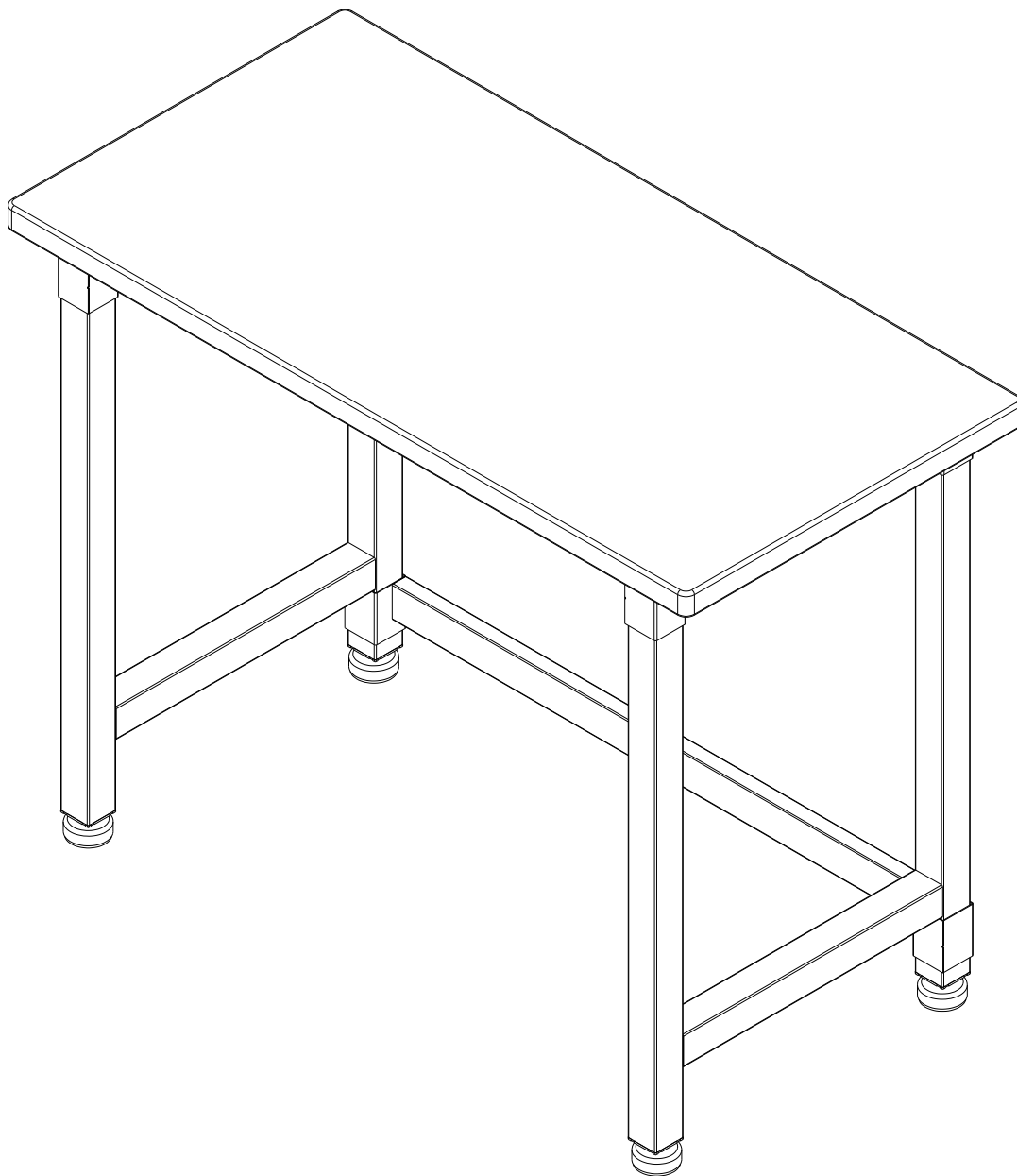

ASSEMBLY INSTRUCTIONS

**UltraHD® Workbench
(Model No. 20287)**

**48 in W X 24 in D X 37.5 in H
(1.21m x 60.9 cm x 95.2 cm)**



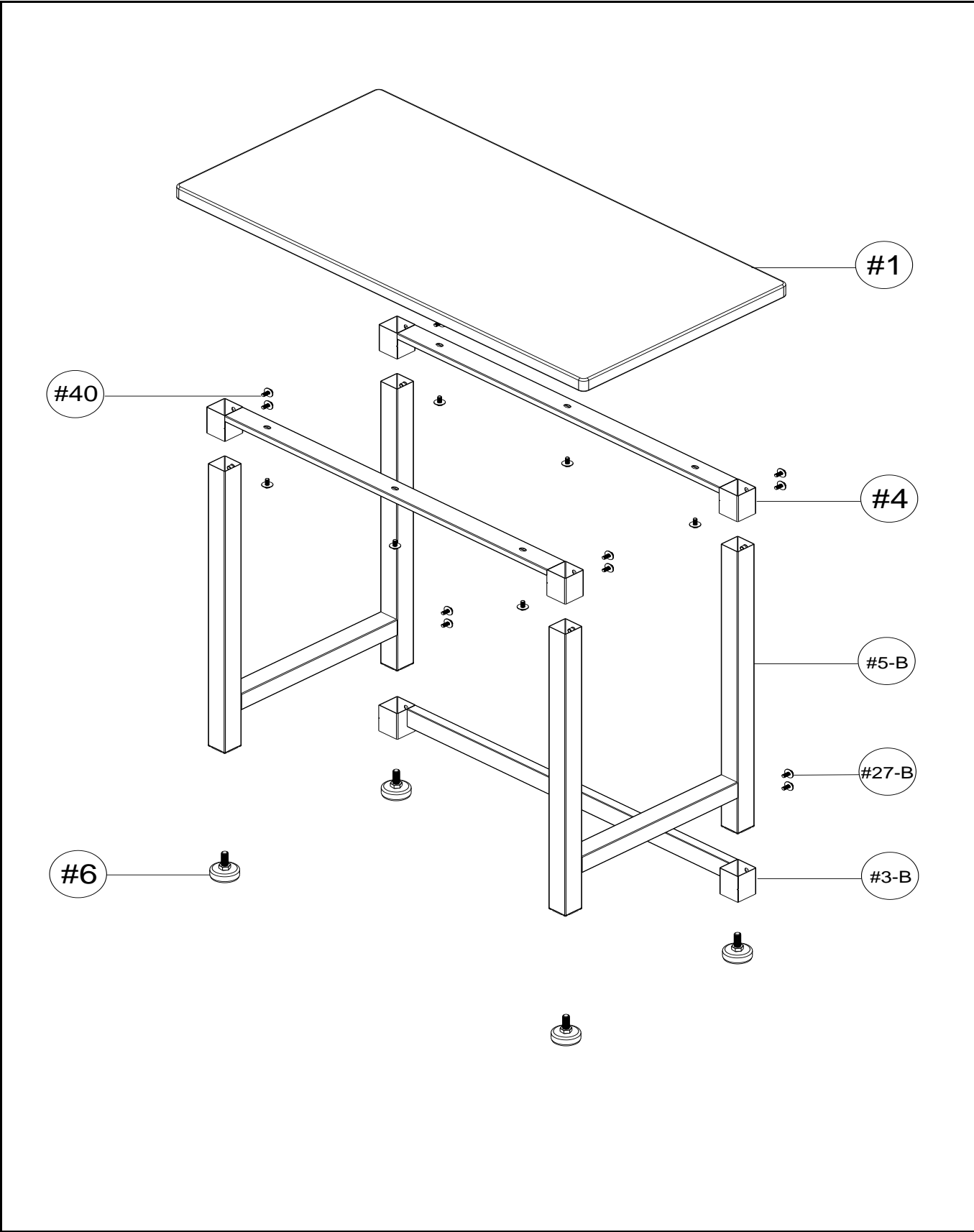

PARTS LIST (pg 2 of 5)

Please check the parts carefully according to the parts list. If you are missing any parts, please call our customer service department (please refer to page 5 of 5) to send you the missing parts.

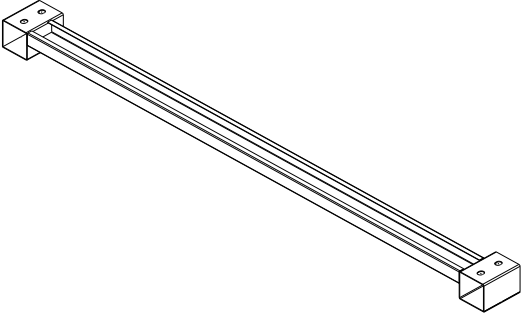
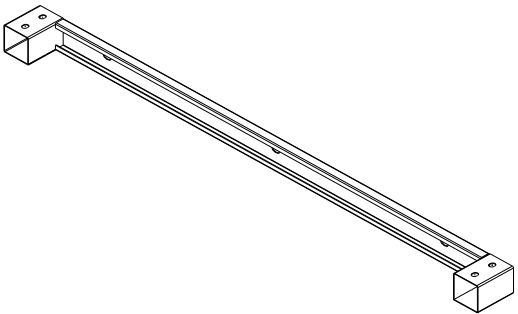
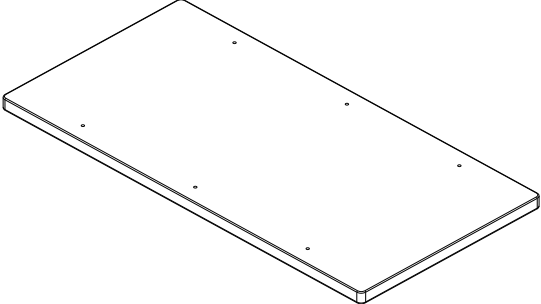
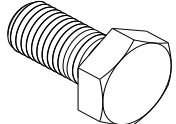
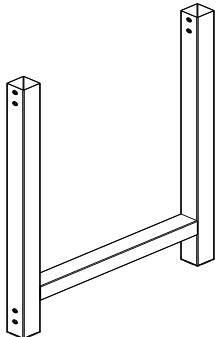
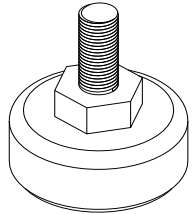
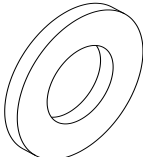
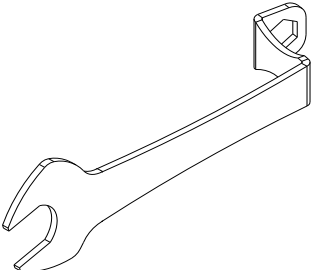
 A long, narrow metal bar with a rectangular cross-section and two small rectangular tabs at each end, one at each end.	 A long, narrow metal bar with a rectangular cross-section and two small rectangular tabs at each end, one at each end.
(#3-B) BOTTOM CROSSBAR x 1 PC	(#4) TOP CROSSBAR x 2 PCS
 A rectangular wooden board with a slightly beveled edge and four small circular holes, one in each corner.	 A hexagonal head screw with a threaded shaft.
(#1) SOLID HARDWOOD TOP x 1 PC	(#40) SCREW E M8 x 18L 18 PCS
 A metal L-shaped bracket with a long vertical leg and a shorter horizontal leg, both with small rectangular tabs at the ends.	 A circular leveling foot with a hexagonal base and a threaded stem.
(#5-B) LEG PIECE x 2 PCS	(#6) LEVELING FOOT x 4 PCS
 A circular metal washer with a central hole.	 A long-handled wrench with a curved head and a small hook at the end.
(#27-B) WASHER x 18 PCS	(#25) WRENCH x 1 PC

UltraHD Workbench (Model No. 20287) (Pg 3 of 5)

***NOTE:** We recommend using TWO people to assemble the work bench.

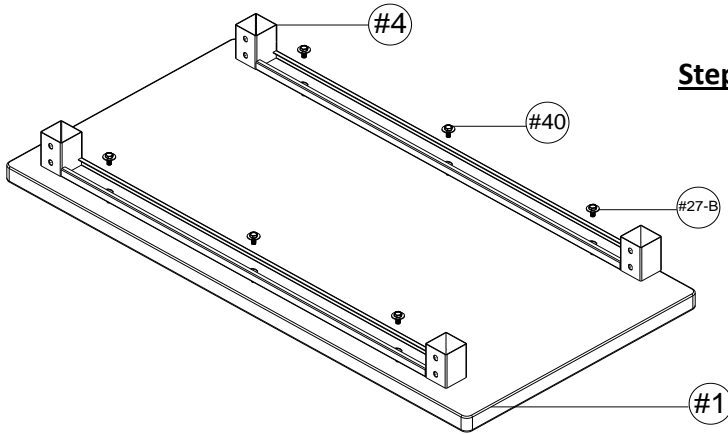

Step 1: Assemble Top Crossbar (#4)

Open the package, remove and place all parts to the side. Then open the package of the Solid Hardwood Top (#1).

Attach both Top crossbars (#4) to the Solid Hardwood Top (#1). Use 6 pcs Screw E (#40) with Washer (#27-B) and Wrench (#25) to tighten.

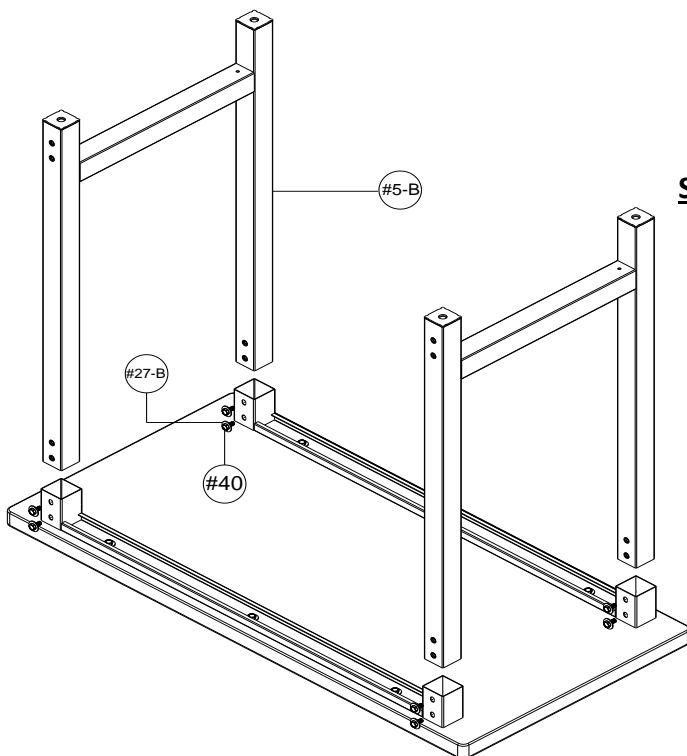
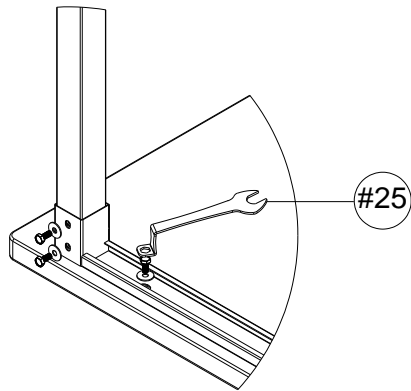

Step 2: Assemble Leg (#5-B)

Insert the Leg(#5-B) into the tube of the Top Crossbar (#4). Use 8 pcs Screw E (#40) with Washer (#27-B) and Wrench (#25) to tighten.

UltraHD Workbench (Model No. 20287) (Pg 4 of 5)

*NOTE: We recommend using TWO people to assemble the work bench.

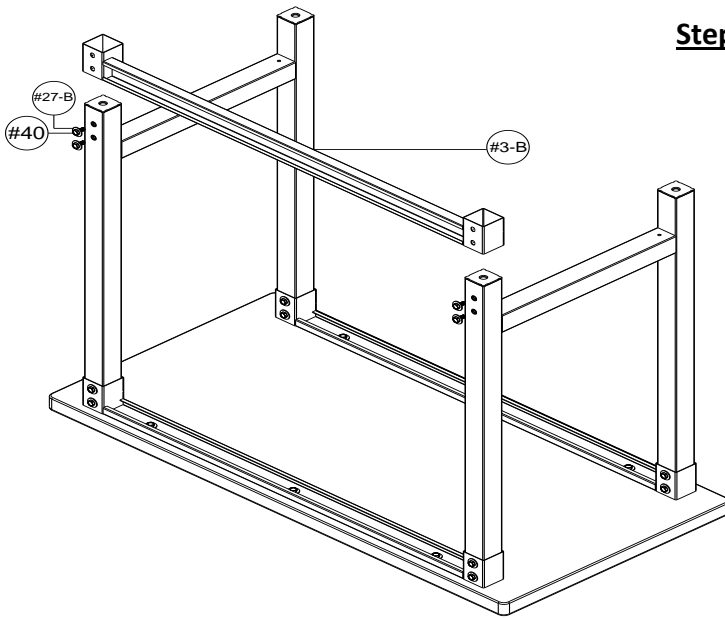

Step 3: Assemble Bottom Crossbar (#3-B)

Attach the Bottom Crossbar (#3-B) to the back of (#5-B) Leg Piece, line up the screw holes, use 4 pcs Screw E (#40) with Washer (#27-B) and Wrench (#25) to tighten.

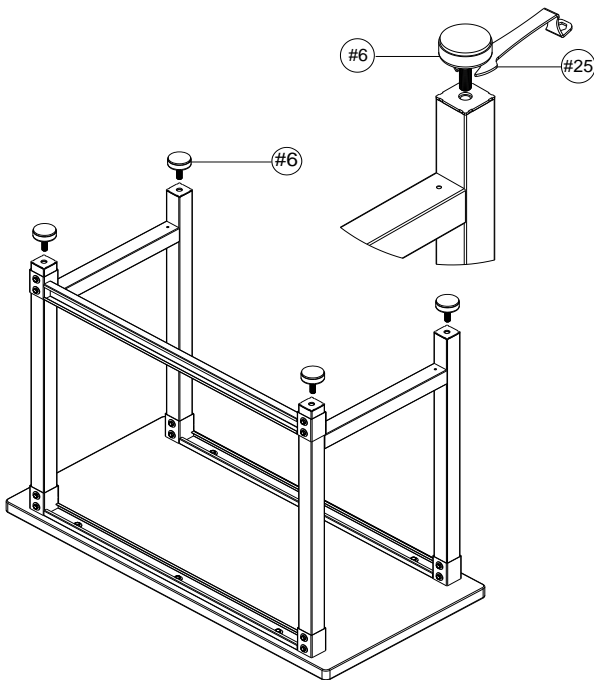

Step 4: Install Leveling Feet (#6)

After installing Bottom Crossbar (#3-B), attach Leveling Feet (#6) to Leg Pieces (#5-B), use Wrench (#25) to tighten.

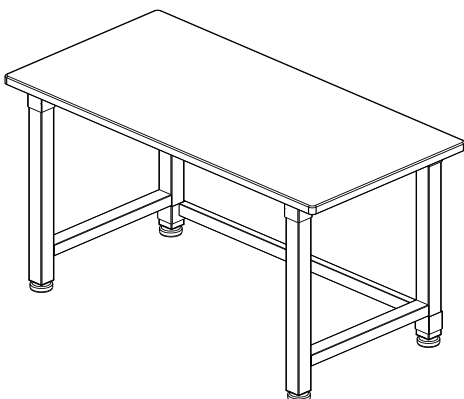

Turn the workbench up right once you finish this step.

CONTACT INFORMATION (pg 5 of 5)

*If you are missing any parts, have any questions, or need additional assistance in assembly, please contact our **bilingual (English/Spanish) customer service department at:**

Seville Classics, Inc.
19401 South Harborgate Way
Torrance, CA 90501
USA

Telephone: (800) 323-5565 within USA

Hours: 9:00am - 4:30pm (Pacific Standard Time)

Fax: (310) 533-3899

E-mail: support@sevilleclassics.com

Website & Online Store: www.sevilleclassics.com

*****Please visit our website or call and inquire about our additional UltraHD Line*****

UltraHD Line

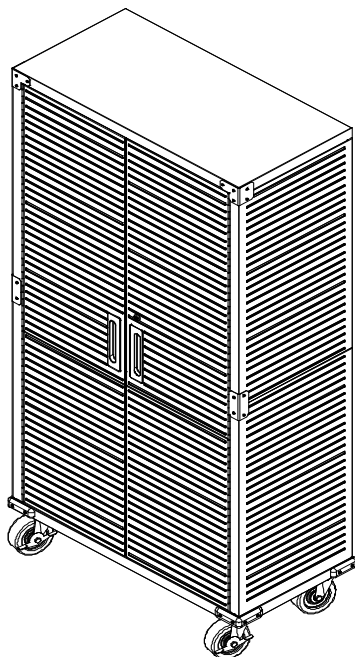

Model No. 16236
UltraHD Storage Cabinet

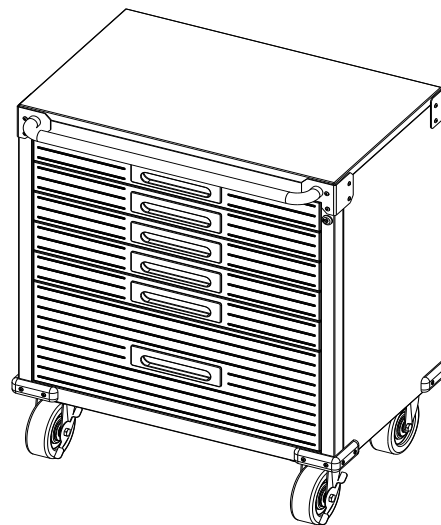

Model No. 20204
UltraHD 6-Drawer Rolling Cabinet

UltraHD Line

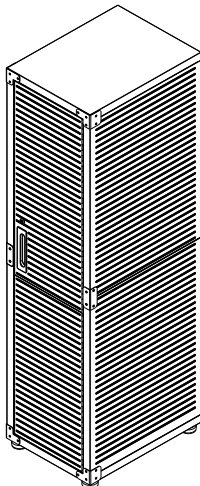

Model No. 16221
UltraHD Locker Gear Cabinet

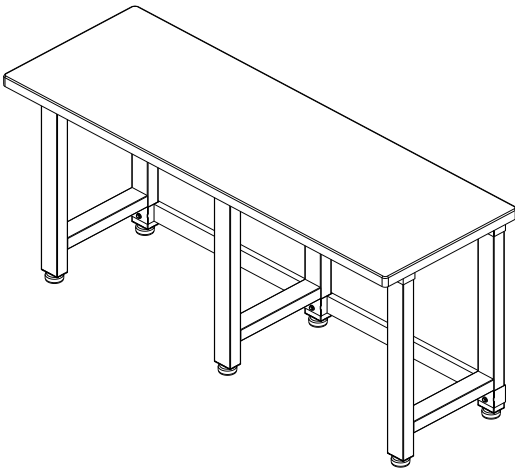

Model No. 20206
UltraHD Workbench

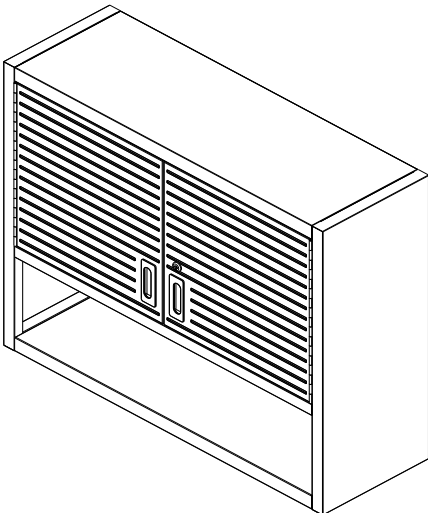

Model No. 20230
UltraHD Wall Cabinet

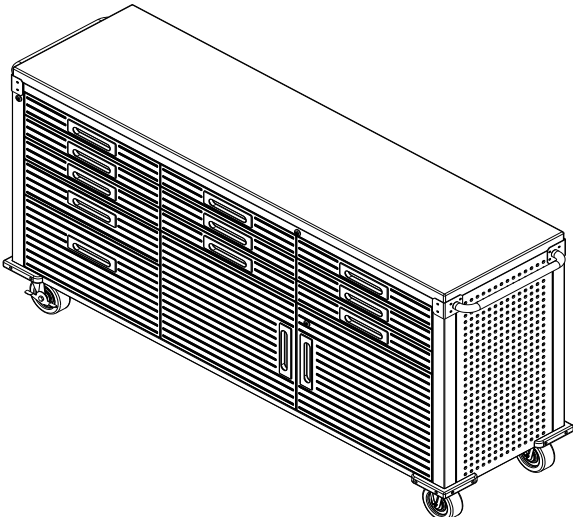

Model No. 20262
UltraHD Rolling Workbench

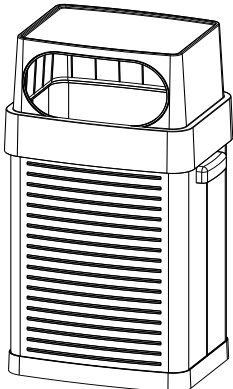

Model No. 20217
UltraHD Trash Bin

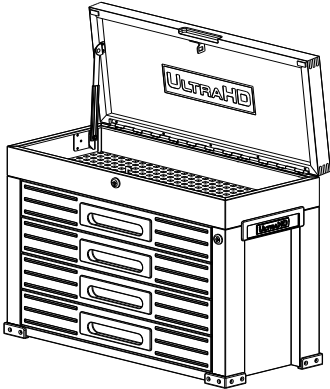

Model No. 20255
UltraHD Tool Box