

Additional parts and accessories are available for purchase online at:  
[www.SevilleClassics.com](http://www.SevilleClassics.com)



**WEB106**  
8-Pack Shelf Label



**WEB274**  
Shelving Liners  
30" x 14" (2-Pack)



**WEB370**  
Steel Wire Shelf  
30" x 14"



**WEB232**  
S-Hook (6-pack)



View assembly online here:  
<https://www.youtube.com/watch?v=N6iRVVqBG-I>

## Caution

- Place heavier items on the lower shelves and lighter ones on the top.
- Do not stand or climb on the shelving system.
- Do not drop heavy items on the system.
- Do not move the system while loaded.

## Specifications

Dimensions: 30" W x 14" D x 48" H (49.5" H with casters)

Weight capacity	Per shelf	Overall
On leveling feet	<b>300 lbs.</b> (136 kg.)	<b>1200 lbs.</b> (544.3 kg.)
On wheels	<b>27.5 lbs.</b> (12.4 kg.)	<b>110 lbs.</b> (49.9 kg.)

## Customer Service Information

**Telephone:** (800) 323-5565  
**Fax:** (310) 533-3899  
**Hours:** 8:30 AM – 4:30 PM (PST)  
**Email:** [Support@SevilleClassics.com](mailto:Support@SevilleClassics.com)  
**Homepage:** [www.SevilleClassics.com](http://www.SevilleClassics.com)

# seville classics®

## 4-Tier Steel Wire Shelving with Casters

### 30" W x 14" D x 48" H

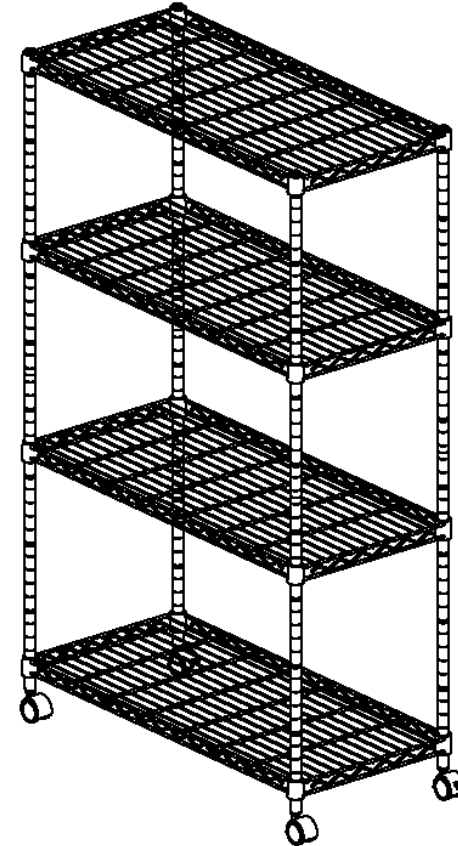





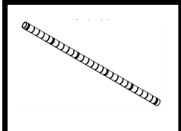

Model #: SHE14304

Thank you for choosing Seville Classics! We hope that you enjoy your steel wire shelving! Please read through this guide for parts list, assembly instructions, frequently asked questions and contact information.

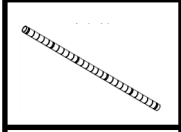
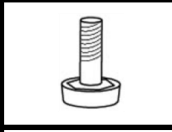
# Parts List

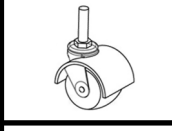
Please make sure you have all the parts on this list.

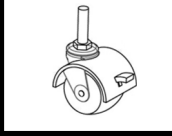
A. Bottom poles (4) (Threaded end)		E. Slip sleeves (16)	
B. Top poles (4) (Plastic cap on end)		F. Leveling feet (4)	
C. Connectors (4) (May be attached to poles)		G. Casters (2)	
D. Shelves (4)		H. Locking Casters (2)	

If you're missing parts, contact us for replacements at (800) 323-5565 or send an email to [Support@SevilleClassics.com](mailto:Support@SevilleClassics.com)

## Assembly Instructions

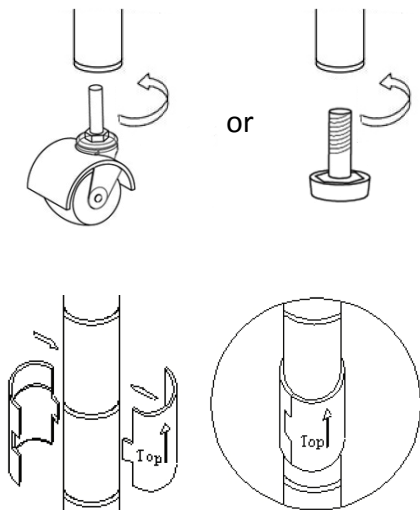

### STEP 1.

Screw **LEVELING FEET (F)** or **CASTERS (G, H)** into base of bottom poles.

Repeat for all bottom poles.

### STEP 2.

Snap **SLIP SLEEVES (E)** around the grooves on **BOTTOM POLES (A)** for your lowest shelf.

**TIP!** Count the number of grooves from the bottom of the pole to keep the height consistent.

1

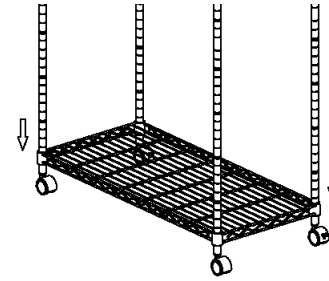

### STEP 3.

Fit **SHELF (D)** over the top of the 4 poles and over **SLIP SLEEVES (E)**.

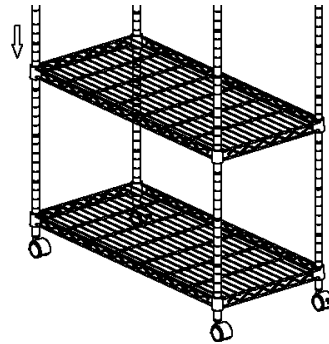

Repeat **STEPS 2-3** for next shelf.

**TIP!** If necessary, lightly tap shelves into place with a rubber mallet.

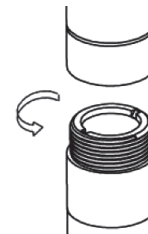

### STEP 4.

Screw **CONNECTORS (C)** into top of **BOTTOM POLES (A)**.

Screw **TOP POLES (B)** to **CONNECTORS (C)**.

**TIP!** Connectors may be pre-installed.

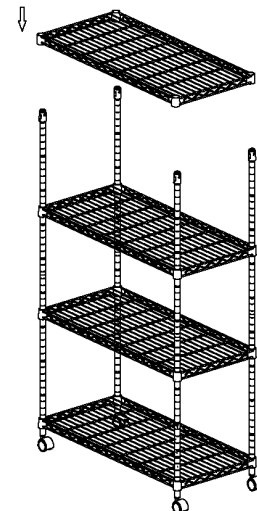

### STEP 5.

Repeat **STEPS 2-3** for remaining shelves.

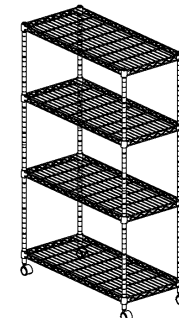

Congratulations!

Enjoy your now complete shelving unit.

2