

4. Bypass Switch- Shift between two functions (Sensor or pull chain) freely. Select the desired working mode. "M" Motion sensor mode, "O" Pull chain mode.

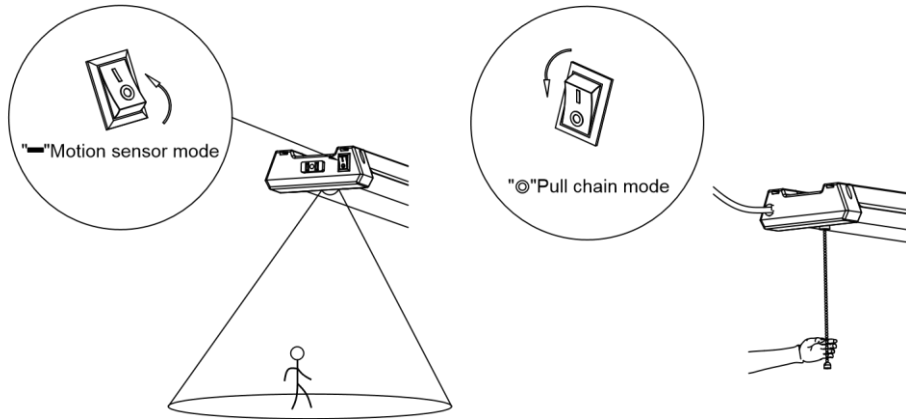

5. Plug the power supply cord into the electrical outlet.

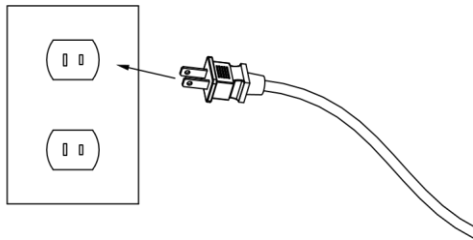

LINKING MULTIPLE SHOP LIGHTS:

The maximum number of connected lamps is 4.

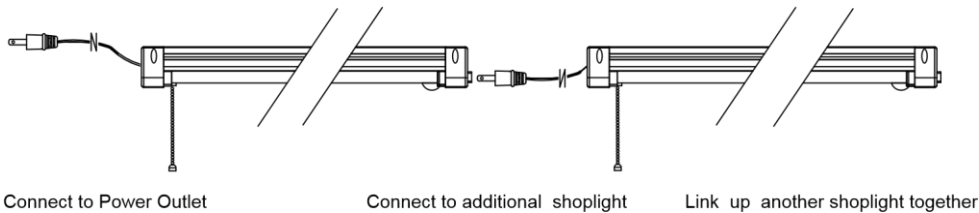

Torrance, CA 90501 USA
www.sevilleclassics.com
© 2019 Seville Classics, Inc.

MADE IN CHINA

LS190307



ASSEMBLY INSTRUCTIONS

UltraHD LED Shop Light

Model No.EHF10235 / WEB627 /
WEB628 /WEB629







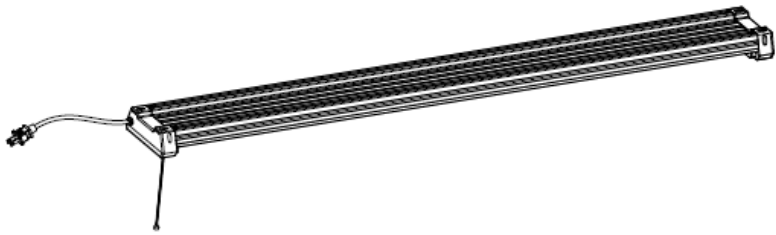

Customer Service:

Tel 1.310.533.3800
Tel 1.800.323.5565
Fax 1.310.533.3899
Monday through Friday
9:00 am - 4:30 pm (Pacific Time)
support@sevilleclassics.com

Unpack and remove all parts from the box. If there are missing or broken parts, please contact our CUSTOMER SERVICE.

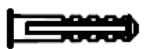
PARTS:

 <p>X 1 LED Shop Light</p>		
 <p>X 2 Hanging Chains</p>	 <p>x 4 "S" Hooks</p>	 <p>x 2 Eye Hook Screws</p>
 <p>x 6 Plastic Anchors</p>	 <p>x 4 Screws</p>	 <p>x 1 Cotton Rope</p>

Rated: 120V-60Hz 40W

**READ ALL THE INSTRUCTIONS AND SAVE THIS INSTRUCTION SHEET.
NOT READING THE INSTRUCTIONS MAY CAUSE RISK OF FIRE OR PERSONAL INJURY**

CAUTION: To reduce the risk of fire, electric shock or injury to people:

- Suitable for damp/dry locations.
- Not for use with dimmers.
- Use only insulated staples or plastic ties to secure the cord.
- Do not install directly over a heat source (stove, etc.)
- Use safety precautions. Safety eye glasses and gloves are recommended.
- Installation should not be made on a radiant-heating ceiling.
- Injury to people and damage to the lamp and/or mounting surface may result if the lamp is pulled from the surface. To reduce the likelihood of such injury or damage, mount only on a mechanically sound surface.
- Please do not link other electrical appliances at the link end.
- Do not alter the plug or power supply cord in any way or try to install this product in any other method besides method shown on this sheet.

NOTE:

1. This fixture complies with Part 15 of the FCC rules. Operation is subject to the following two conditions:
(1) this device may not cause harmful interference, and (2) this device must accept any interference received, including interference that may cause undesired operation.
2. To install onto a plaster board surface, plaster board requires minimum 3/8" thick.

STYLE 1 INSTALLATION INSTRUCTIONS:

1. Mounting surface must be capable of supporting the fixture. If the surface is made of plaster board, we recommend that you use minimum #8 screw eye hooks with plastic anchors (included) or expansion bolts (not included). If installed onto a plaster board surface, We recommend minimum 3/8" thick.

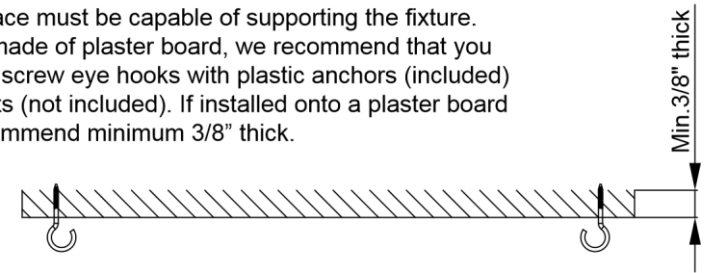

2. Install the 2 plastic anchors 47 1/4" apart, then screw the eye hook into each anchor.

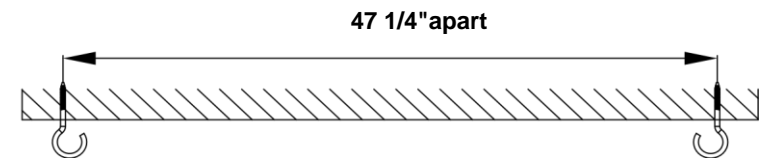

3. Install one "S" hook into each end of the chain, then crimp the "S" hook end which is attached to the chain with pliers. (Leave one side open from the "S" hook) Repeat step for the second chain provided.

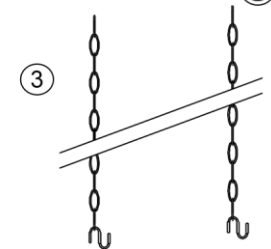

4. Install the "S" hook from one end of the chain into the end cap of the LED shop light, then crimp the hooks end with pliers. Repeat same step for the opposite side.

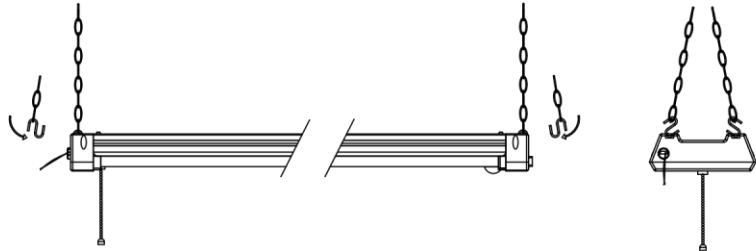

5. Bypass Switch- Shift between two functions (Sensor or pull chain) freely. Select the desired working mode. "—" Motion sensor mode, "O" Pull chain mode.

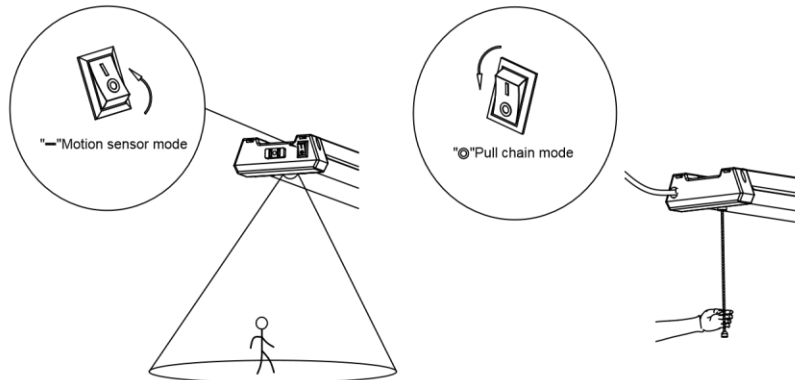

6. Install the LED lamp with chains, one end at a time onto each screw eye hook. Once installed, crimp each of the "S" hooks end with pliers.

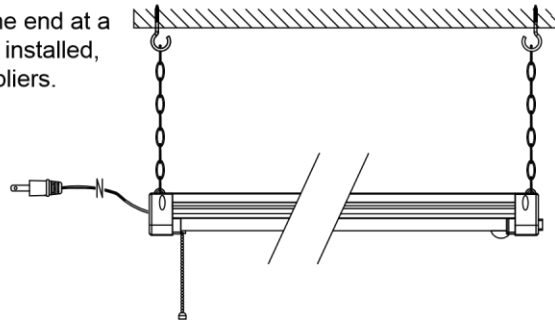

7. Plug the power supply cord into the electrical outlet.

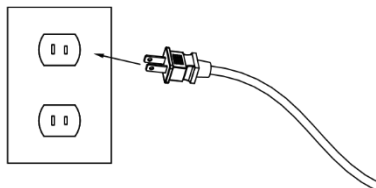

STYLE 2 INSTALLATION INSTRUCTIONS:

1. Mounting surface must be capable of supporting the fixture. If the surface is made of plaster board, we recommend that you use minimum #8 screw eye hooks with plastic anchors (included) or expansion bolts (not included). If installed onto a plaster board surface, We recommend minimum 3/8" thick.

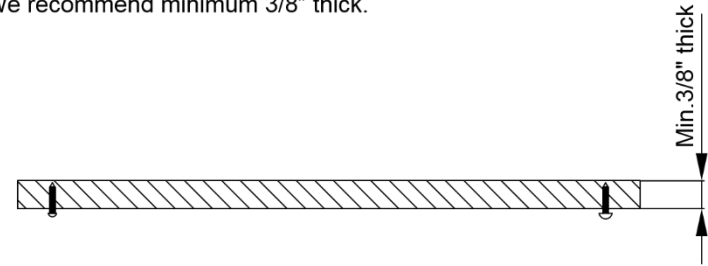

2. Install the 4 plastic anchors 46 1/2" apart and 3.189" apart, then screw the eye hook into each anchor. Spacing between ceiling and cap nut should be at least 1/3".

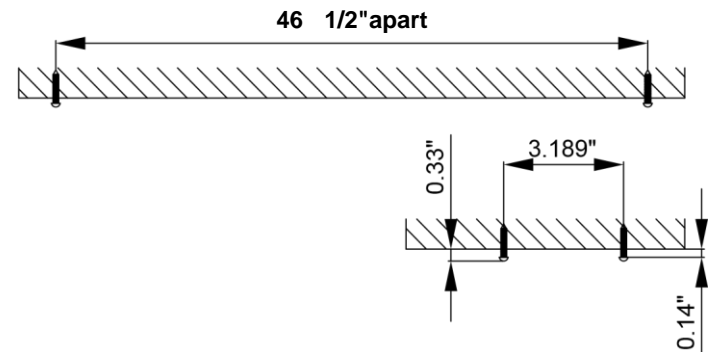

3. Lift fixture up to screws and slide to one side to secure into place.

Screw size:ST4X30

